

**AdrTech**

All the technology you need

## Virtual / Digital Classroom

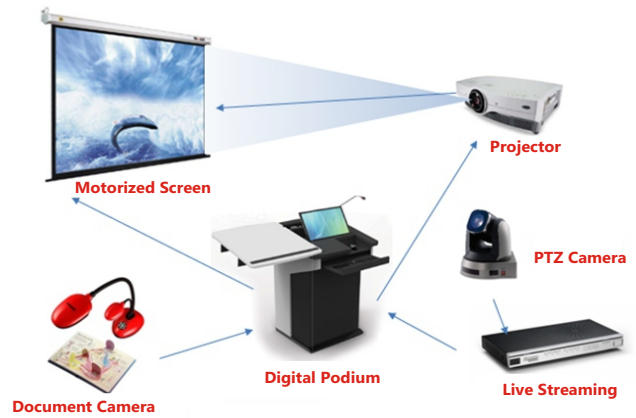

### Smart Class/ Conference Room Solutions

- Digital Podium
- Interactive Kiosk
- Interactive White Board
- Projector
- Digital Notice Board Solution
- Audio Podium
- Indoor / Outdoor Video Wall Solutions
- Video Conferencing System

### Building Automation/ Industrial Automation Solutions

- CCTV Surveillance System
- Access Control System
- Public Address System
- Intrusion Alarm System
- LED Based Live Information Display System



### IOT/AI/ML Lab Setup Solutions

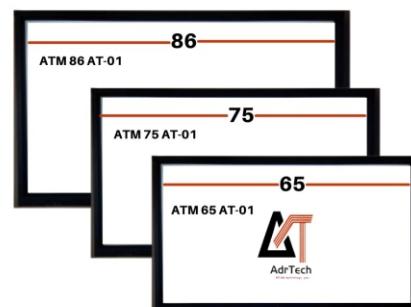
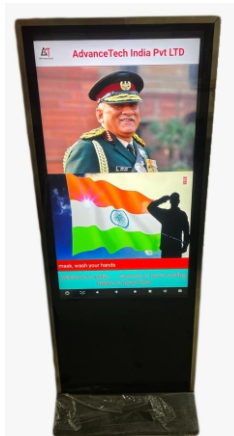

## Company Profile

- ❖ AdvanceTech India Pvt. Ltd. is a design house. It provides out-of-the-box solution from concept to reality. It is registered with Small Scale Industries with Zirakpur (PB) Administration. We are registered in **ISO, NSIC, MSME & GEM Portal**. AdvanceTech India Pvt Ltd consists a group of talented and experienced business professionals who are dedicated to maintaining a standard of excellence, while providing personalized services and the highest quality of Products at the lowest price as possible as in the market place.
- ❖ Our well - versed executives, engineers are all trained in this field for years together and successfully developed latest technologies as well as gained managing capabilities. AdvanceTech India Pvt Ltd a dream, nursed a mission, now ready to cross the miles. Located at Zirakpur(PB), one of the beautiful city of India. . The Company has built a resource of base of high innovate professionals and state-of-art Manufacturing in a very short time.
- ❖ AdvanceTech India Pvt Ltd as been identified as a reputed and innovative manufacturer of Electronics Hardware & Software. Today the company has grown progressively with a composite infrastructure base and a strong liquidity. Now we look forward to serving the vide Industrial & Consumer Customers by providing state-of-the-art equipments, Services & Solutions.

## List of Our Customer

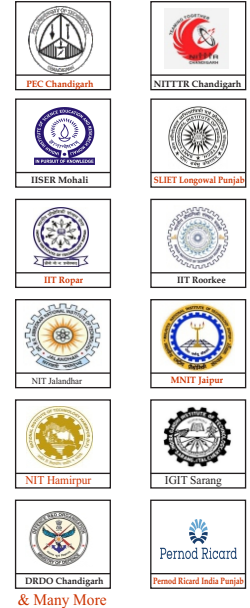

## Glimpse & Installation of Our Audio Video Solutions



### Smart Classroom & Conference Solutions

### Virtual / Digital Classroom



Digital Podium, Audio Podium & Podium with Front Screen

Touch Screen Kiosk

22" & 43"



AdvanceTech India Pvt. Ltd  
Register with MSME (NSIC) - Govt Of India



Available  
On GEM

# Touch Screen Kiosk



❖ Interactive Kiosk has been designed to offer the best intelligent features, with best information we offer various models, with touch and size 22"/43"/55" kiosk. They can be used for variety of function including web browsing, product browsing & many functions and can be integrated with other applications.

TECHNICAL SPECIFICATION			
Model	ATIPL-IK01	ATIPL-IK01	ATIPL-IK01
<b>Construction</b>	Enclosure: 1.6 mm thick Mild steel , floor mounted with and screw less chassis.		
DISPLAY			
<b>Type</b>	LED with Touch Monitor		
<b>Size</b>	21-22"	43"	55" - Portrait
<b>Resolution</b>	1920 x 1080	1920X1080	1920X1080
<b>Brightness</b>	250/m2 (NITS) Brightness	250/m2 (NITS) Brightness	300/m2 (NITS) Brightness
SYSTEM DETAILS			
<b>Processor</b>	Dual Core / Android Version	Dual Core / Android Version	Dual Core / Android Version
<b>Memory</b>	4/8 GB	4/8 GB	4/8 GB
<b>HDD/Storage</b>	500GB/1000GB	500GB/1000GB	500GB/1000GB
<b>Expansion I/O</b>	1 x USB, 1 x LAN	1 x USB, 1 x LAN	1 x USB, 1 x LAN
<b>Audio</b>	1 x Line-out /1 x Line-in	1 x Line-out /1 x Line-in	1 x Line-out /1 x Line-in
<b>Speaker</b>	Optional	Optional	Optional
<b>Window</b>	Window 10	Window 10	Window 10
APPLICATION AREA			
Entertainment	E-Government	Education	Banking System Management
Hospital	Industrial	Hospital	System Management
Telecom	Retail	Corporate	Analytics & Reporting

## Basic Digital Podium

❖ Digital Podium has been designed to offer the best intelligent features, with best information we offer various models, with touch and size 21.5" podium.

### ❖ Construction

❖ **Enclosure** : 1.6mm Mild Steel and screw less chassis, wheel based cabinet having space for keyboard, Mouse, Computer, Visualizer, P.A System, Microphone etc

### ❖ Display

Type;-Color LED touch Screen/ Non Touch Size 21.5" inches Resolution 1980x1080 pixels

### ❖ System Details

❖ **RAM**:- 4GB/8GB, **HDD/ Storage** -500GB/ 1TB, **Expansion I/O**- 1 x USB, 1 x LAN,

**Audio** 1 x Line-out / 1 x Line-in, **VGA/LAN** Yes, **Speaker** : 60 W Amp, 15 W Wallmount Speakers (2 pcs.)

❖ **Operating System**:- Windows 8/10 | **CPU**: i3, i5 or i7 (as per Requirement)

Gooseneck Mic, Hand Held Mic with audio in & out (Wireless Mic and Receiver Optional)

\* **Note** : The processor / screen specs are subject to change, from model to model



## Advanced Digital Podium

### ❖ Construction

❖ **Enclosure** : 1.6mm Mild Steel and screw less chassis, wheel based cabinet having space for keyboard, Mouse, Computer, Visualizer, P.A System, Microphone etc

### ❖ Front Display 32" (Non Touch) with Android Interface

Type;-Color LED touch Screen Size 21.5" inches Resolution 1980x1080 pixels

### ❖ System Details

**RAM**:- 4GB/8GB, **HDD/ Storage** -500GB/1TB, **Expansion I/O**- 1 x USB, 1 x LAN,

❖ **Audio** 1 x Line-out / 1 x Line-in, **VGA/LAN** Yes, **Speaker** : 60 W Amp, 15 W Wallmount Speakers (2 pcs.)

❖ **Operating System**:- Windows 8/10 | **CPU**: i3, i5 or i7 (as per Requirement)

Gooseneck Mic, Hand Held Mic with audio in & out (Wireless Mic and Receiver Optional)

\* **Note** : The processor / screen specs are subject to change, from model to model



## Mini Digital Podium

• It includes a built-in **100 W amplifier** and speaker. A flexible gooseneck microphone and light are provided as well.

• **15" LED Display**

• Inbuilt OS : **Windows 10 or Android**

• **Bluetooth, USB & FM** Facility Available

• Flexible gooseneck MIC's and lamp.

• Two MIC's Inputs, one line Input and four AUX Inputs.

• With two UHF handholds wireless MIC's, maximum range 100 Meters.

• Finish : Black | Wooden Top and Steel bottom, Steel body.



## Audio Podium

- ❖ It includes a built-in **60/100 W amplifier** and 15/25 W speaker. A flexible gooseneck microphone and light are provided as well.
- ❖ Wireless MIC / Along with Wireless Receiver Available if Required
- ❖ **Bluetooth, USB & FM** Facility Available
- ❖ Flexible gooseneck MIC's and lamp.
- ❖ Two MIC's Inputs, one line Input and four AUX Inputs.
- ❖ With two UHF handholds wireless MIC's, maximum range 100 Meters.
- ❖ Finish : Black | Wooden Top and Steel bottom, Steel body.



## Interactive White Board

- ❖ **Technology:** IR, **Aspect Ratio 4:3**
- ❖ **Board :** Laminate Surface / Ceramic Surface, Active Area 2000mm
- ❖ Multi-Touch 10 Points **Size** 78 to 95 Inch
- ❖ Input Finger, Stylus & Pen
- ❖ **Resolutions** 32767
- ❖ Accuracy 1mm, Surface USB, USB Type A-B
- ❖ Calibrated with Customized Software
- ❖ WALL MOUNTED STANDARD
- ❖ Scratch resistance surface & infrared multi touch technology

Available  
On GEM

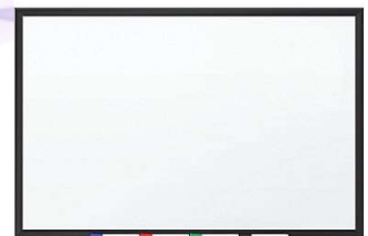

## Digital Signage Solutions

- ❖ You Can broadcast your content in minutes to any number of screens and locations.
- ❖ Digital Information Board System is a highly powerful and flexible communication method.
- ❖ Digital Information Board software works over an Internet connection, or LAN connection delivering rich media content to digital screens.
- ❖ Digital Notice Board can be used by all companies and organizations who seek to quickly and easily distribute information among people
- ❖ You can push information via our customized software and can display information in multiple formats - Images, Video, Text and Live Website
- ❖ Multiple feature like delay time and ticker information can be put along with wide variety of background colors
- ❖ The display size is available in - 22" 32" 43" and 55"
- ❖ Wall Mount and Floor Mount orientation is available as per required

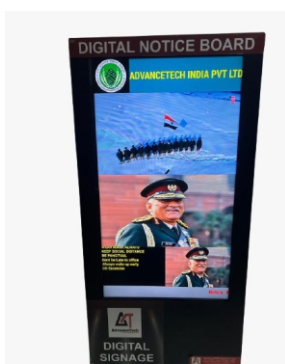
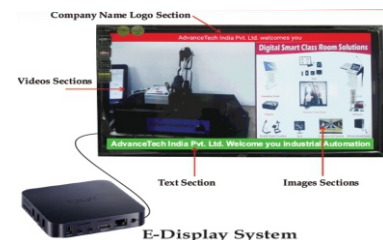

22"/32" Wall Mount Portrait Signage

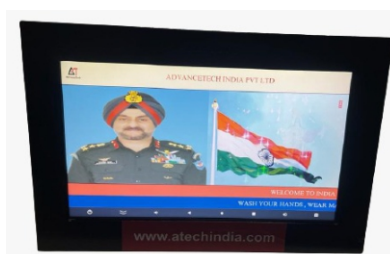

22"/32" Wall Mount Landscape Signage



32"/43 Floor Mount Signage

## Interactive LED based Touch Screen

Available  
On GEM

- ❖ Latest LED based highly advance Interactive screen with 55" ,65" ,70" ,75" ,86" Inch
- ❖ With PC and Android OS system, support OPS for windows.
- ❖ Now use finger /pen to write on the same display screen and save In USB drive.
- ❖ Direct Internet / lan /wi- fi/ connectivity .
- ❖ Optional facility for software based video conferencing .
- ❖ Multi-touch interactive touch screen .
- ❖ Various input and output for multi output capacity.
- ❖ Easy Maintenance One can easily operate the whole system.



## Video Conference Solution

Available  
On GEM

- ❖ We offer complete audio video solution and offer customized solutions for Board room and conference halls.
- ❖ Live Video projection on screen, Cloud Based & Codec Based Video conferencing (1+3, 1+5, 1+9)
- ❖ Live audio solutions ,for conference , using PA systems.
- ❖ Video conferencing solutions with PTZ Camera and Speaker Microphone
- ❖ Personalized data transfer using Mobile and laptops.
- ❖ **Make :** People link, Clear one



## Indoor / Outdoor Video Wall Display Solutions

- ❖ We offer industrial display solutions with MODBUS Compatible and can be connected with MODBUS supported display in real time data in various formats .
- ❖ Can be communicate through GSM , GPRS , Ethernet , etc.
- ❖ The system can be programmed using LAN cable the same displays can be used for video display also.
- ❖ Available in P4, P6 and P10 Pixel Pitch Resolution
- ❖ Available in 3x2 cross to 6x4 and other customized Orientation as per requirement
- ❖ **Application Area :-** Large public display areas like Hospitals , Industries, Advertisement, Railways Stations, Schools / Colleges / Universities, Industry for Safety and production targets etc.

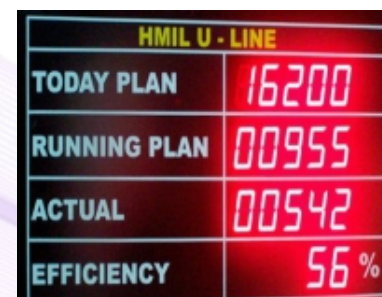

# IOT/AI/ML Lab Setup Solutions

We offer complete lab smart lab setup solution involving Hardware and Software to the Universities, Engineering Collages and Research Institutes  
Multiple application of IOT lab includes :

IOT based agriculture applications

IOT based environment applications

IOT based home automation system

IOT based water quality system

IOT based air quality system

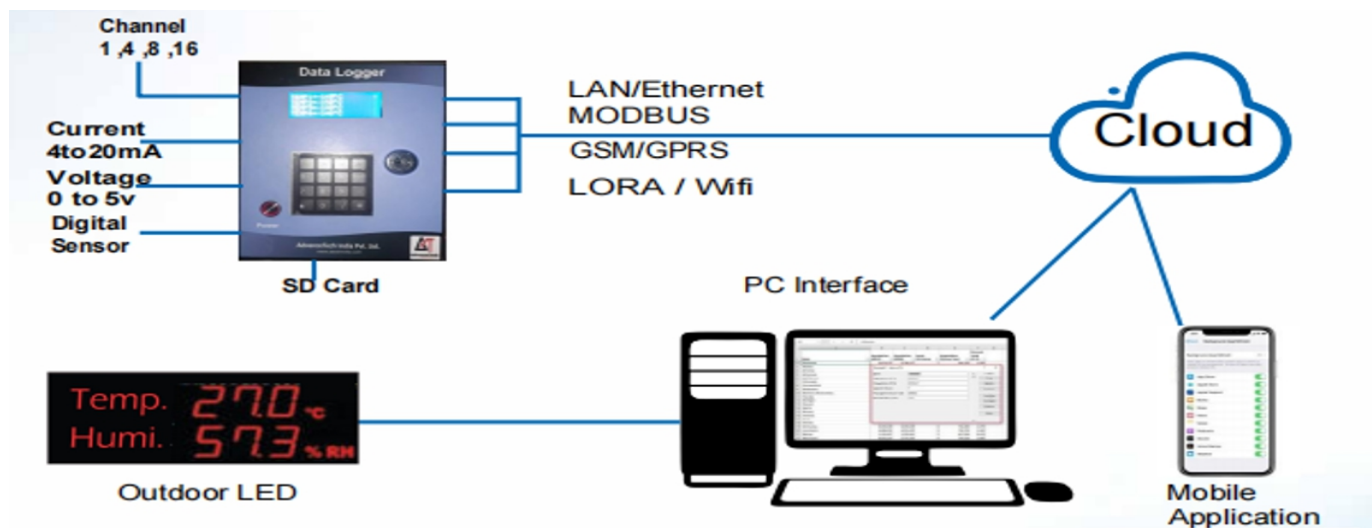

## Common Features

- Display : (16x2) LCD
- Channel : 1, 4, 8, 16
- Current : 4 to 20 mA
- Voltage : 0 to 5V
- Keypad : 4x4 Matrix
- Digital CH : Modbus
- External Signal Conditioner

## Applications

- Temperature Monitoring
- Humidity Monitoring
- Level Monitoring
- Gas Monitoring
- Soil Parameters
- Or any Other Parameters
- Counter+Timer Applications

Agri-Environment Monitoring Solution also Available



Automatic Weather Station

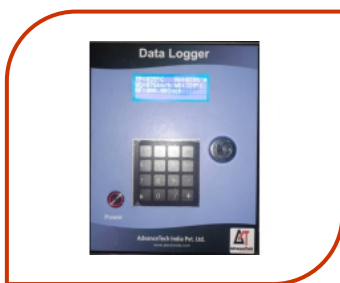

Multipurpose Data Loggers



Multipurpose Data Loggers

## EMBEDDED BASED MICROCONTROLLER TRAINER KIT

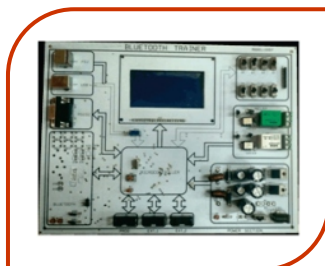

# ADVANCETECH PRESENCE IN MULTIPLE ORGANIZATIONS

## A Glimpse of our few Case Studies



**NAL Air Force Station  
Bikaner**



**PGIMER,  
Chandigarh**



**Punjab University  
Chandigarh**

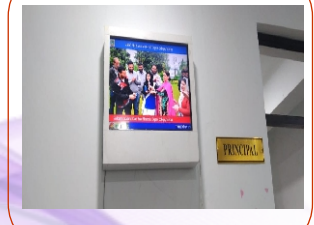

**National Research  
Development  
Corporation, Delhi**

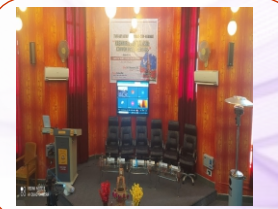

**University of  
Kashmir**



**Indian Army  
Bikaner**

## Our Prime Customers

- \* **INDIAN ARMY JAMMU**
- \* **INDIAN AIRFORCE BIKANER**
- \* **INDIAN AIR FORCE AMBALA**
- \* **WESTERN COMMAND - PANCHKULA**
- \* **INDIAN ARMY DEHRADUN**

- \* **IIT INDORE**
- \* **NEELIT ROPAR**
- \* **KNIT SULTANPUR**
- \* **UNIVERSITY OF KASHMIR**
- \* **IIM ROHTAK**
- \* **PERNOD RICARD**

**500+ DIGITAL PODIUMS INSTALLED**

**EXPERTISE IN INDUSTRIAL AUTOMATION SOLUTIONS**

**100+ SMART CLASS SETUPS PROVIDED**

**CUSTOMIZED BUILDING AUTOMATION SOLUTIONS**

**200+ INTERACTIVE KIOSKS INSTALLED**

**REMARKABLE SERVICE AND INNOVATIVE SOLUTIONS**



**AdvanceTech India Pvt.Ltd**

formerly Advance Technology (An ISO 9001 :2008 Company)

Phone :9815036923, 8587996986

Email :-atechindia@gmail.com

Website :www.atechindia.com,

